

# ARGO FIXED 206F

# mara®

## DESCRIPTION / DESCRIZIONE

**en** The Argo multifunctional tables collection expands with the new fixed version. A product that, in its simplicity, is solid and robust and can be inserted both in work environments and residential contexts. The double conical steel leg is enriched by functional contrasting feet that evoke elegance and lightness.

**it** La collezione di tavoli multifunzionali Argo si amplia con la nuova versione fissa. Un prodotto che, nella sua semplicità, è solido e robusto e può essere inserito sia in ambienti di lavoro che in contesti residenziali. La doppia gamba conica in acciaio è impreziosita da funzionali piedini a contrasto che evocano eleganza e leggerezza.

ARGO FIXED  
fixed table  
tavolo fisso

206F

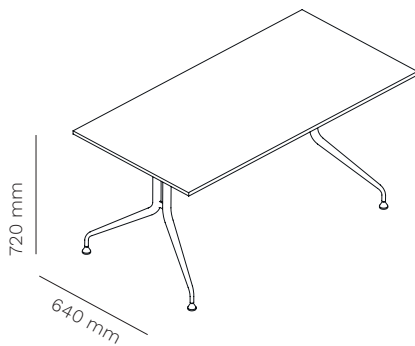

top  
1400/2000 x 700/800 mm



<b>2 LEGS</b> 2 GAMBE	6,4 Kg	1 pc 0,073 mc	27 pcs / EU pallet
<b>1 BEAM 1400 - 1600 mm</b> 1 TRAVERSA 1400 - 1600 mm	6,5 kg	1 pc 0,039 mc	50 pcs / 135 x 110 cm pallet
<b>1 BEAM 1800 - 2000 mm</b> 1 TRAVERSA 1800 - 2000 mm	7 kg	1 pc 0,050 mc	50 pcs / 175 x 110 cm pallet

**ARGO FIXED**  
206F

**mara**<sup>®</sup>

**ACCESSORIES / ACCESSORI**

**511PLUS**



**top access with flip cover**  
passacavi con sportello

**511EPLUS**



**top access with multifunctional sockets**  
passacavi con prese multifunzione

**PASD60**



**multifunctional sockets**  
Ø 60 mm  
prese multifunzione  
Ø 60 mm

**PASD80**



**multifunctional sockets with wireless charging**  
Ø 80 mm  
prese multifunzione con ricarica wireless Ø 80 mm

**299FP**

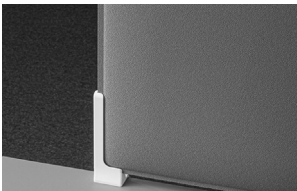

**sound-absorbing panel**  
pannello fonoassorbente

**215KIT**



**nylon kit for connection**  
agganci in nylon

**300**

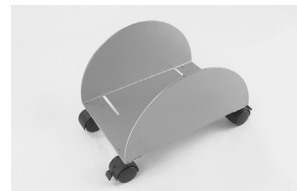

**cpu holder**  
portaserver

**500DROLL**



**mobile storage system, on castors**  
cassetiera mobile su ruote

**8001**



**hanging cpu holder**  
portaserver pensile

**215V**



**cable tray to fix under top (2,7kg)**  
vasca porta cavi fissaggio sotto piano (2,7 kg)

**206FR**



**modesty panel**  
pannello frontale

**ARGO FIXED**  
206F

**FRAME / STRUTTURA**

**powder coated steel**  
acciaio verniciato



**chromed steel**  
acciaio cromato



**TOP / PIANO**

**standard colour and material effect laminate tops**  
piani standard in laminato colore ed effetto materico



**standard colour and wood melamine tops**  
piani standard in nobilitato colore e legno



**standard FENIX tops**  
piani standard in FENIX

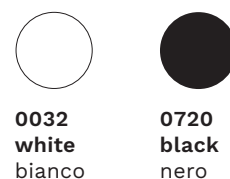

**ACOUSTIC PANEL**  
PANNELLO FONOASSORBENTE



299FP

**DESCRIPTION / DESCRIZIONE**

**en** The sound-absorbing panel made with Snowsound technology is an excellent solution for dividing worktops by creating a visual barrier and optimising acoustic comfort. Application to the surface using special clamps. The panel has an Italian Class1 fire reaction and Euroclass B-s2, d0. The panel is 100% recyclable and has no detectable formaldehyde content according to UNI EN 717-2. The panel has been tested in reverberation chamber according to UNI EN ISO 354 and obtained "Acoustic Absorption Class A", in accordance with UNI EN ISO 11654.

**it** Il pannello fonoassorbente realizzato con la tecnologia Snowsound è un'ottima soluzione per suddividere i piani di lavoro creando una barriera visiva ed ottimizzando il comfort acustico. Applicazione al piano mediante appositi morsetti. Il pannello ha Classe1 Italia di reazione al Fuoco ed Euroclass B-s2, d0. Il pannello è riciclabile al 100% e ha un contenuto di formaldeide non rilevabile secondo la norma UNI EN 717-2. Il pannello è stato testato in camera riverberante secondo la norma UNI EN ISO 354 ed ha "Classe di Assorbimento Acustico A", in accordo con la norma UNI EN ISO 11654.

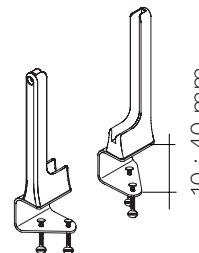
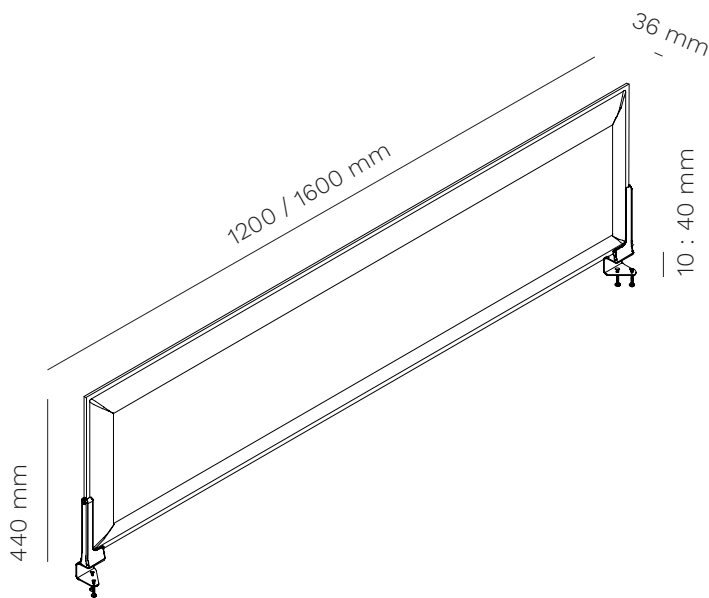

**en** Pair of brackets with clamp in powder-coated steel and zamac for connection to the desk top.

**it** Coppia attacchi in zama con morsetto in acciaio verniciati con polveri epossidiche per fissaggio al piano della scrivania.



1200 x 440 mm  
2,3 kg



1600 x 440 mm  
3,9 kg



**kit 2 brackets**  
kit 2 attacchi  
1,3 kg

**fire-retardant fabric**  
tessuto ignifugo



8004



8007



2005



8033



3008



7004



6071



4027

CLEANING AND MAINTENANCE / PULIZIA E MANUTENZIONE

STEEL / ACCIAIO

**en** Our types of metals include: chromed metals and painted metals. Do not use acid or alkaline based cleaning products. Do not use detergents, steel wool, dishwashing detergents or the like. Sharp or pointed objects may damage the surface. Any hot or wet object may cause surface damage. Clean the surface regularly with a soft cloth to remove dust. To remove light dirt, use a soft cloth and a neutral household cleaner.

**it** Le nostre tipologie di metallo comprendono: metalli cromati e metalli verniciati. Non utilizzare prodotti per la pulizia a base acida o alcalina. Non utilizzare detergenti, lana di acciaio, detersivi per stoviglie o simili. Oggetti appuntiti o taglienti possono danneggiare la superficie. Qualsiasi oggetto caldo o bagnato potrebbe provocare danni alla superficie. Pulire la superficie regolarmente con un panno soffice per rimuovere la polvere. Per rimuovere lo sporco leggero utilizzare un panno soffice e un prodotto per le pulizie di casa neutro.

CHROMED STEEL AND ALUMINIUM POLISHED / ACCIAIO CROMATO E ALLUMINIO LUCIDO

**en** Do not use acid or alkaline based cleaning products. Do not use detergents, steel wool, dishwashing detergents or the like. Sharp or pointed objects may damage the surface. Any hot or wet object may cause surface damage. Clean the surface regularly with a soft cloth to remove dust. To remove light dirt, use a soft cloth and a neutral household cleaner

**it** Non utilizzare prodotti per la pulizia a base acida o alcalina. Non utilizzare detergenti, lana di acciaio, detersivi per stoviglie o simili. Oggetti appuntiti o taglienti possono danneggiare la superficie. Qualsiasi oggetto caldo o bagnato potrebbe provocare danni alla superficie. Pulire la superficie regolarmente con un panno soffice per rimuovere la polvere. Per rimuovere lo sporco leggero utilizzare un panno soffice e un prodotto per le pulizie di casa neutro.

LAMINATE AND MELAMINE / LAMINATI E NOBILITATI

**en** Laminates and melamine products guarantee high performance in terms of resistance to scratches, shocks and abrasions. Keep furniture away from direct sunlight; furniture in direct sunlight may tend to discolour over time. Do not use acid or alkaline based cleaning products. Sharp or pointed objects can damage the surface. Laminate and melamine furniture can be cleaned using a mixture of liquid soap and hot water. Rinse with cold water and dry with a paper towel or damp cloth.

**it** Laminati e nobilitati garantiscono alte prestazioni di resistenza ai graffi, agli urti e alle abrasioni. Mantenere i mobili lontani dalla luce diretta del sole; i mobili che si trovano alla luce diretta del sole potrebbero tendere a scolorire nel tempo. Non utilizzare prodotti per la pulizia a base acida o alcalina. Oggetti appuntiti o taglienti possono danneggiare la superficie. E' possibile effettuare la pulizia dei mobili in laminato e nobilitato usando una miscela di sapone liquido e acqua calda. Sciacquare con acqua fredda e asciugare con un tovagliolo di carta o un panno umido.

STANDARD FENIX TOPS / PIANI STANDARD IN FENIX

**en** Cleaning FENIX means cleaning its structure. You can do this with warm water. As FENIX is a strong material, you can also use any household cleaner – even solvents like acetone \* if needed. However, to avoid damaging the structure, don't scrub it with abrasive cream, a scouring pad or a hard brush; in the long-term, this might lead to a glossy spot on your matt surface. Instead, you can use a melamine sponge – also known as a magic sponge. As a final step, to avoid anything staying behind in the structure – whether that's dirt or residue from your cleaner – always rinse afterward with warm water and wipe dry with a clean cloth.

\* always follow safety instructions

**it** Pulire FENIX significa pulirne la struttura. Si può farlo, usando acqua tiepida. Poiché FENIX è un materiale resistente, si può utilizzare qualsiasi detergente per la casa, se necessario anche un solvente come l'acetone \*. Tuttavia, per evitare di danneggiare la struttura, è consigliabile evitare di strofinarla usando una crema abrasiva, una spugna abrasiva o una spazzola con setole dure; nel tempo, ciò potrebbe portare alla formazione di un'area lucida sulla superficie opaca. Si può piuttosto utilizzare una spugna in melamina, nota anche come spugna magica.

Come ultimo passaggio, per evitare la formazione di depositi nella struttura, che si tratti di sporco o residui del detergente, risciacquare sempre con acqua tiepida e asciugare con un panno pulito.

\* seguire sempre le istruzioni di sicurezza.

**TOP ACCESS**  
PASSACAVI

511E

**mara**<sup>®</sup>

**DESCRIPTION / DESCRIZIONE**

**en Aluminium top access with flap. Black brush.**

**it Passacavi in alluminio con spazzola nera.**

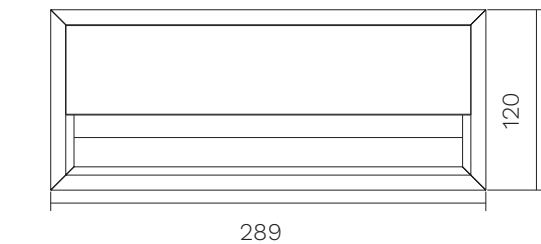

**All measurements are indicated in mm**  
Tutte le misure sono indicate in mm

**Surface cut-out area**

Area di taglio della superficie

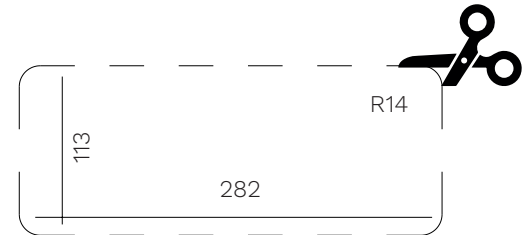

**COLOURS AVAILABLE / COLORI DISPONIBILI**



**aluminium**  
alluminio



**black**  
nero



**TOP ACCESS WITH INTEGRATED POWER UNIT**  
**PASSACAVI CON MULTIPRESA INTEGRATA**

**mara**<sup>®</sup>

511EPLUS

**DESCRIPTION / DESCRIZIONE**

**en** Top access with integrated power unit for table tops max 30 mm thick, available in aluminium or black colour, 289x120 mm with 2 mt. power cable + 2 DE sockets + 2 USB 5V/2, 4A + 2 RJ45 sockets.

**it** Passacavo con multipresa integrata per piani tavoli spessore max 30 mm, disponibile nei colori alluminio o nero, 289x120 mm con 2 mt. di cavo di alimentazione + 2 presa DE + 2 prese USB 5V/2, 4A + 2 prese RJ45.

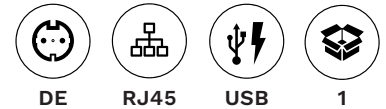

**Optional (on demand)\*:**  
 Opzionali (su richiesta)\*:

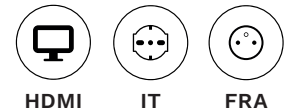

\* dedicated quotation / quotazione dedicata

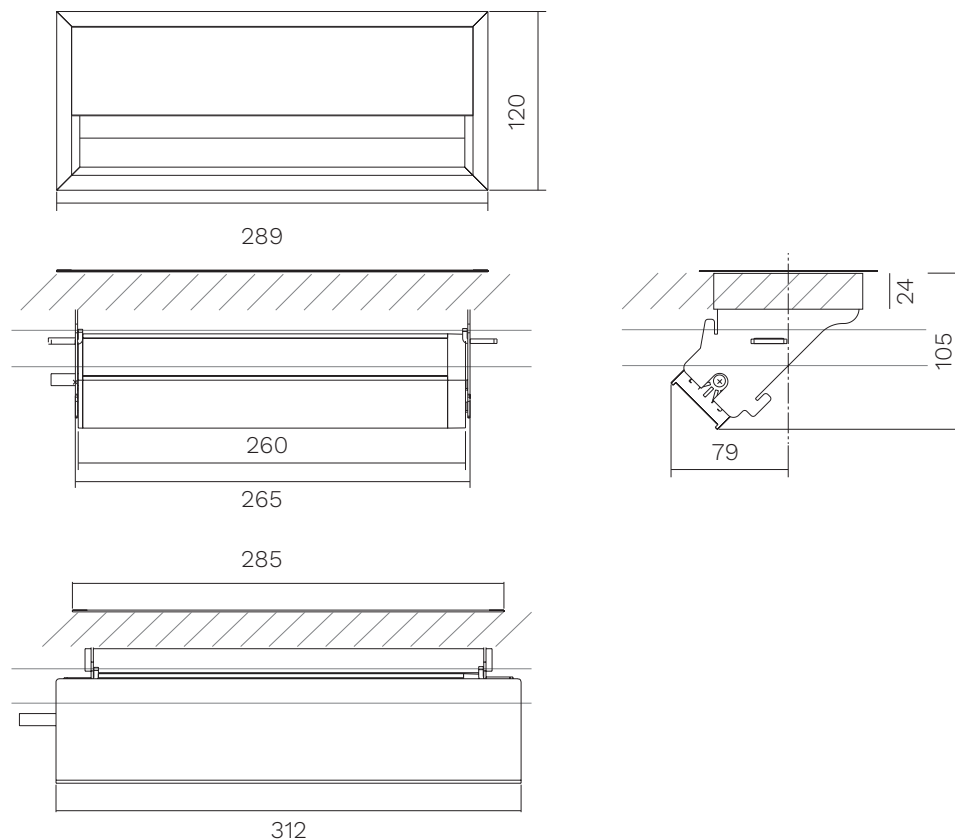

**Surface cut-out area**  
 Area di taglio della superficie

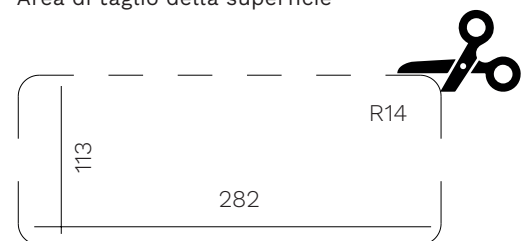

All measurements are indicated in mm  
 Tutte le misure sono indicate in mm

**COLOURS AVAILABLE / COLORI DISPONIBILI**

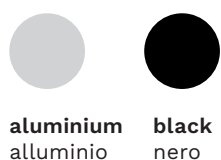

# TOP ACCESS WITH INTEGRATED MULTIFUNCTIONAL SOCKET

## PASSACAVI CON MULTIPRESA INTEGRATA

# mara®

PASD60

### DESCRIPTION / DESCRIZIONE

**en** Top access round with integrated multifunctional socket for table tops, available in white or black colours, diameter 60 mm with 2 mt. power cable + 1 DE + 1 USB 5V/2, 4A.

**it** Presa multifunzione rotonda per piani tavoli, disponibile nei colori bianco o nero, diametro 60 mm con 2 mt. di cavo di alimentazione + 1 presa DE + 1 presa USB 5V/2, 4A.



**Optional (on demand)\*:**  
Opzionali (su richiesta)\*:

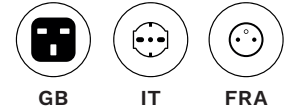

\* dedicated quotation /quotazione dedicata

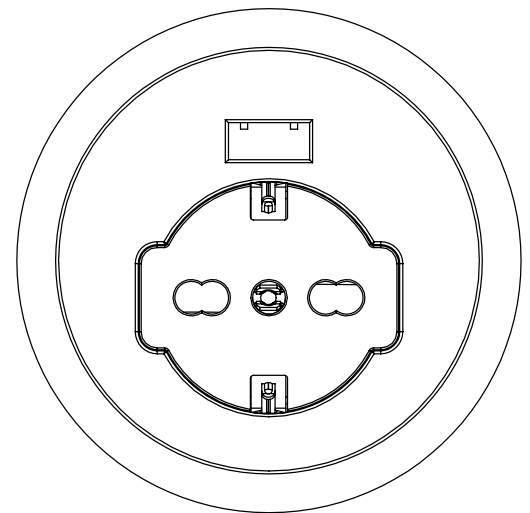
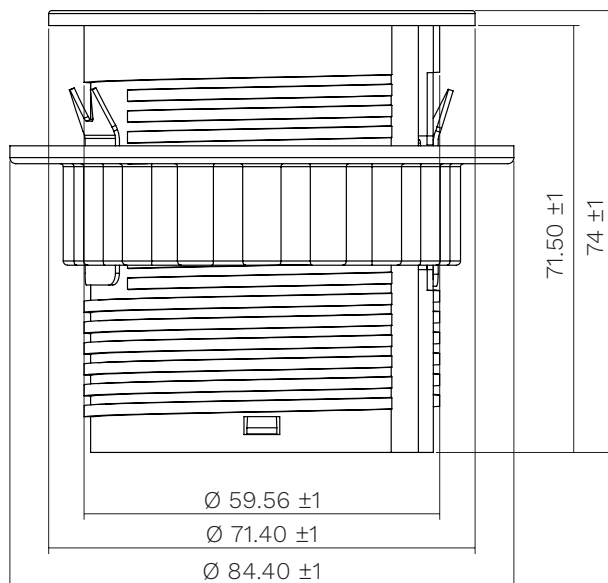

**Surface cut-out area**  
Area di taglio della superficie

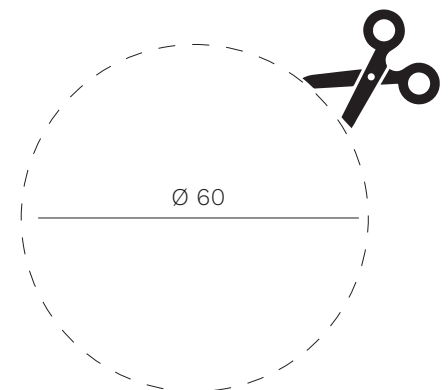

All measurements are indicated in mm  
Tutte le misure sono indicate in mm

### COLOURS AVAILABLE / COLORI DISPONIBILI



**white**  
bianco



**black**  
nero





**CABLE MANAGEMENT WITH INTEGRATED MULTISOCKET**  
**PASSACAPO CON MULTIPRESA INTEGRATA**



PASD80

**DESCRIPTION / DESCRIZIONE**

**en** Top access round with integrated multifunctional socket for table tops, available in white or black colours, diameter 80 mm with 2 mt. power cable + 1 DE + 1 USB 5V/2, 4A socket + 1 RJ45 (interchangeable). The inside of the cover is equipped with a wireless charger (usable only when open).

**it** Presa multifunzione rotonda per piani tavoli, disponibile nei colori bianco o nero, diametro 80 mm con 2 mt. di cavo di alimentazione + 1 presa DE + 1 presa USB 5V/2, 4A + 1 presa RJ45 (intercambiabile). L'interno del coperchio è provvisto di caricatore wireless (utilizzabile solo quando aperto).

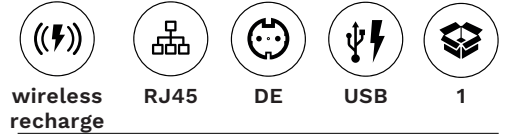

**Optional (on demand)\*:**  
 Opzionali (su richiesta)\*:

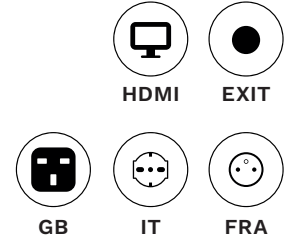

\* dedicated quotation and minimum order  
 \* quotazione dedicata e minimo d'ordine

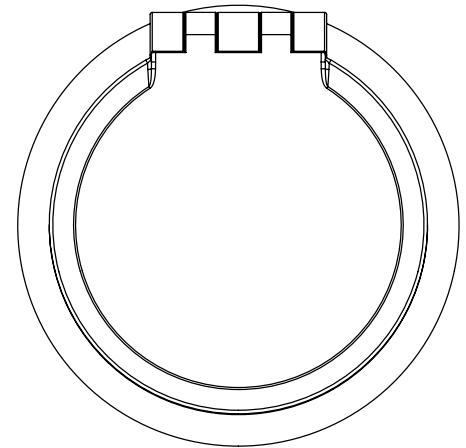
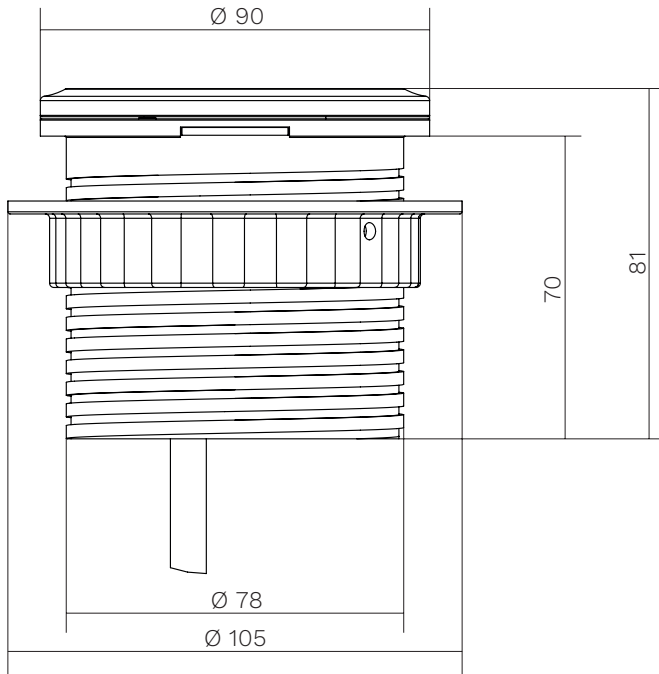

**Surface cut-out area**  
 Area di taglio della superficie

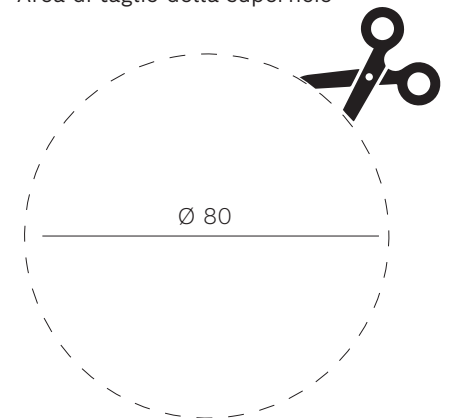

All measurements are indicated in mm  
 Tutte le misure sono indicate in mm

**COLOURS AVAILABLE / COLORI DISPONIBILI**

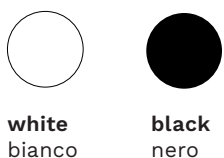



**en** All the energy used in our company is 100% green and comes exclusively from renewable sources.

**it** Tutta l'energia utilizzata nella nostra azienda è 100% GREEN e proviene esclusivamente da fonti rinnovabili.

**en** As it is always seeking to improve its products, the company reserves the right to modify or upgrade the products without prior notice, at any time. Colors should be considered purely indicative. Mara's Collections are worldwide protected by the industrial property right and patents.

**it** Mara, sempre alla ricerca del miglioramento dei propri prodotti, si riserva la facoltà di apportare modifiche costruttive e funzionali in qualsiasi momento senza alcun preavviso. I colori dei materiali sono da ritenersi puramente indicativi. Tutte le collezioni Mara sono protette nel mondo dal diritto di proprietà industriale e da brevetti registrati.