

MARKANT

'It's about the way you work'

Max collection

Dynamic Working



Markant
circular

MARKANT

Healthy employees are more productive, happier and enjoy longer employability. Markant Dynamic workplaces are perfect for Activity Based Working. People are invited to stand up, move about and be physically active in the workplace.

As a result, office workers are more productive, healthier and have more fun. Interests of both employers and employees are best captured by a Markant Dynamic Working office.

A MAX workstation is easy to transform from a comfortable sitting desk to an active standing desk. The rapid adjustability of the work surface allows for sitting and standing work to be alternated with comfort and ease. With Markant, the number of hours spent sitting in the office on a daily basis can be substantially reduced.

Scientific research has shown that Dynamic Working can significantly reduce the occurrence of serious health problems.





DYNAMIC WORKING

Markant stands for Dynamic Working and facilitates this by developing furniture lines that make working healthily, simple and enjoyable. Employees determine their own level of activity during their working day. Dynamic workers are more healthy and productive because they alternate sitting, standing, walking and general movement.

- MAX is the world's best solution for grouped sit-stand workstations.
- Matrix is ideal for individuals or for combinations of workplaces in small spaces.
- Workways is a social seating program, with a complete collection of modular elements.
- Oxiseat combines office work with physical activity, presenting a separate sit-stand workstation.
- Oxidesk is a compact, flexible workspace in which Oxiseat is integrated with an existing adjustable worktop.

Markant Dynamic Working is an investment in health, productivity, creativity and employee satisfaction.



CONCENTRATION WORKSTATIONS

To collaborate from different locations and time zones requires innovative methods. Informal work environments within an office increase employee interaction, creativity and the exchange of ideas. Mobile workers are encouraged to spend more time at the office.

Privacy and acoustics are essential elements for concentration-based workplaces like call centres and quiet work spaces.

The MAX Screen range provides working groups with upholstered walls around the workplace to absorb noise and provide privacy. These screens are fully integrated into the MAX System screens and facilitate cabling in and around the workstation cluster. These end screens may also be used to mark out different departments in the workplace.

Hybrid seating offers various combinations of elements suitable for informal meetings, relaxed working or even a comfortable yet private, concentration space.



Wing concept: 90% more primary work space

Maximum worktop height 128cm

Height of system screen 120 cm. Result: A uniform, sophisticated and calm working environment

Integrated armrests offer ergonomic support both seated and standing

Panels are easily adjusted in color and acoustics

MAX DYNAMIC MEETINGS

Have you ever had meetings where half of the team are just about to fall asleep? Standing up helps to keep your meetings short and sweet!



By standing up during meetings people stay concentrated and focussed. Thus meetings will be faster, smarter and more innovative. Activated muscles promote blood circulation, increasing the rate at which oxygen and glucose is transported to the brain. Oxygen and nutrients are essential for focus, creativity and productivity.

A stand-only meeting table provides for substantial gains and savings. The meeting capacity is almost doubled as there is no need for chairs. Essentially, meetings have more capacity, less need for space, no expensive chairs, shorter and more productive meetings.



SUCCESSFUL IMPLEMENTATION OF DYNAMIC WORKING

Having a specifically designed Dynamic Working environment does not automatically make a workplace healthier or more productive.

People need time to change their lifestyle. The time required may vary between one week and three years or even longer.



Eye contact with the 120 cm high System screen

Dynamic Work often starts with standing meetings, preferably with a disciplined two minute break every half hour.

Key success factors for the implementation of a Dynamic Workspace include management leading by example and making small steps forward.

The ROI (Return On Investment) highly depends upon the specific program of implementation for Dynamic Working. This is essential for assuring that all furniture will actually be used dynamically, resulting in the best ROI.

Markant encourages and facilitates a step-by-step implementation. The majority of workstations supplied will be traditionally sit workstations. Only a few workplaces of health conscious users will be ordered and installed as a sit-stand desk.

As more employees understand the benefits of Dynamic Working, sit-stand drive units will be gradually supplied and installed for these specific persons or workgroups. This will upgrade sit workstations into sit-stand workstations.

A shortage of sit-stand workstations imprints on employees that working healthily is a privilege, not a chore.

FROM WORKING SITTING ...

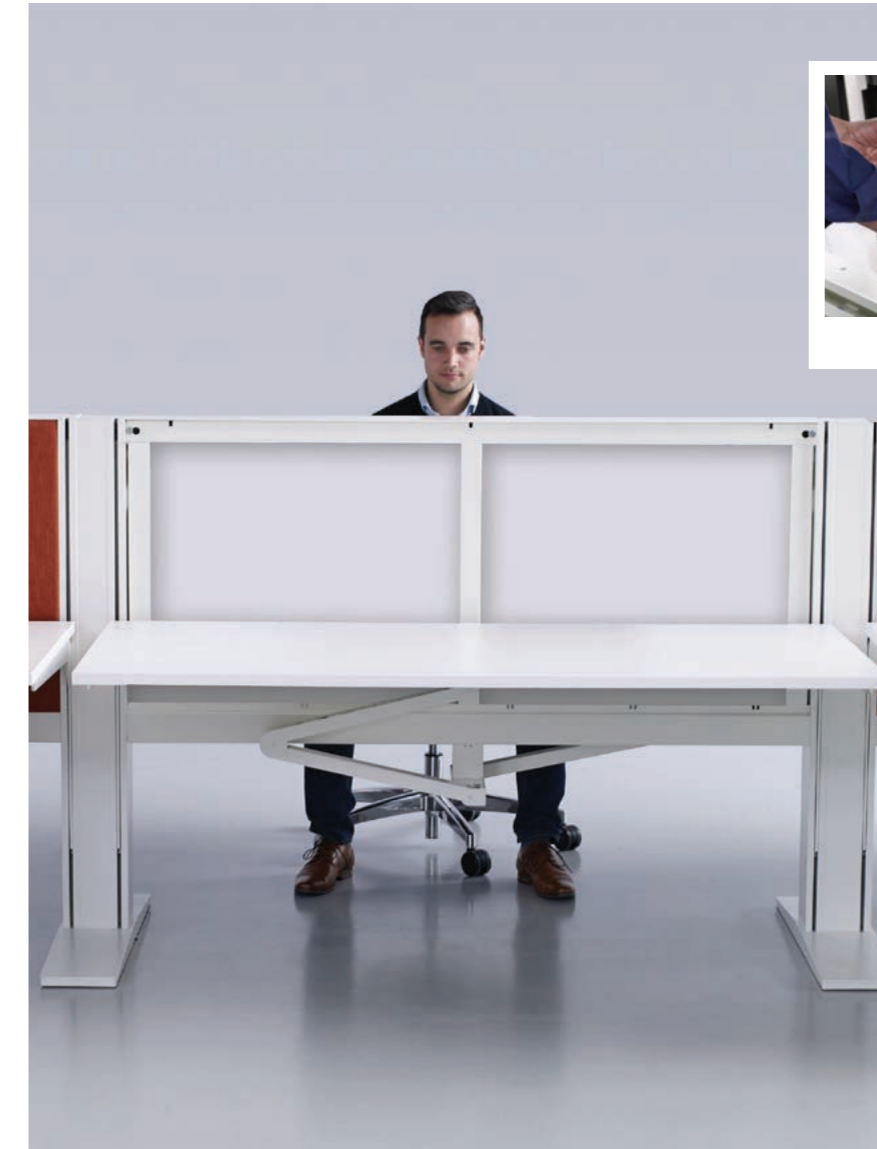

Sit workstation where MAX System screen is configured as Technician Adjust (HI).

... TO DYNAMIC WORKING



Simple retrofitting

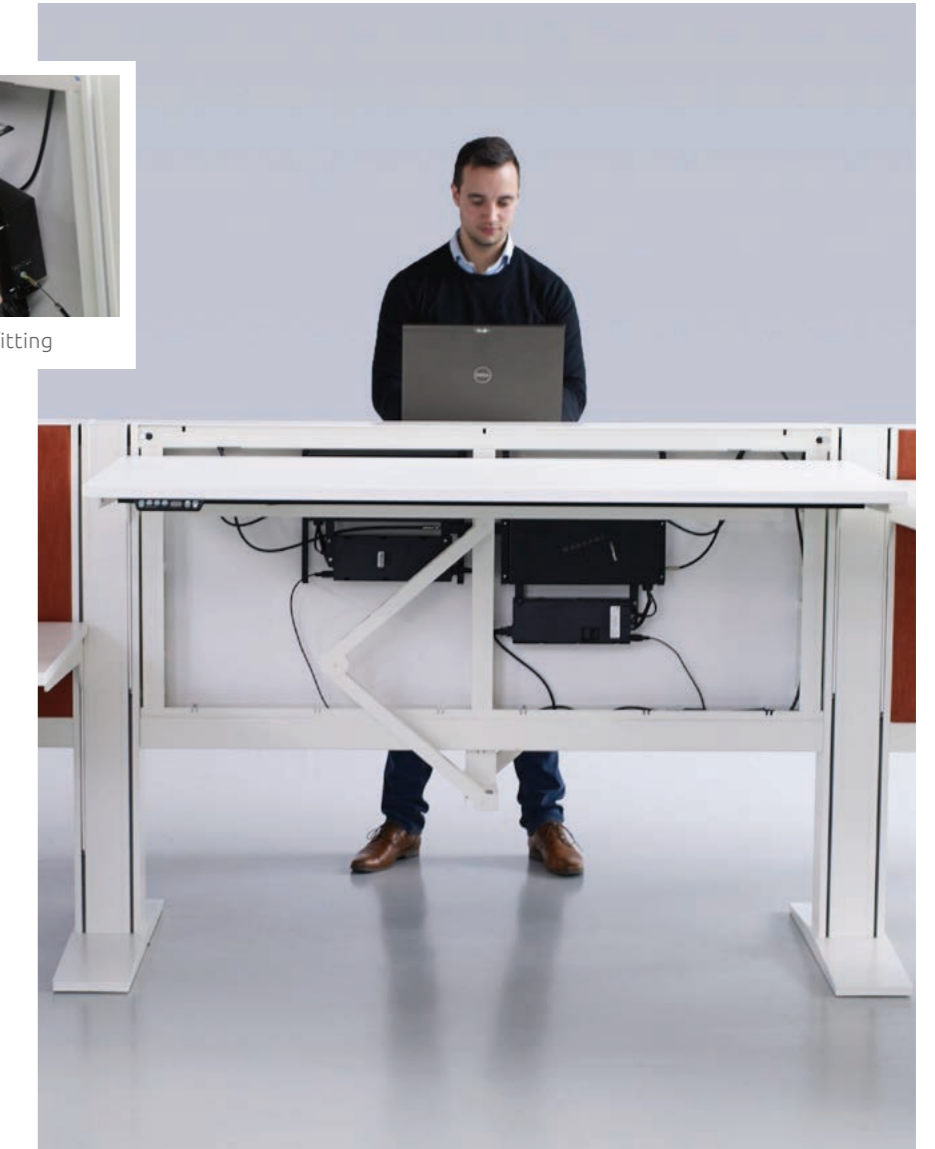

After mounting the drive unit a workstation is ready for Dynamic Working

FOR BETTER HEALTH AND PRODUCTIVITY

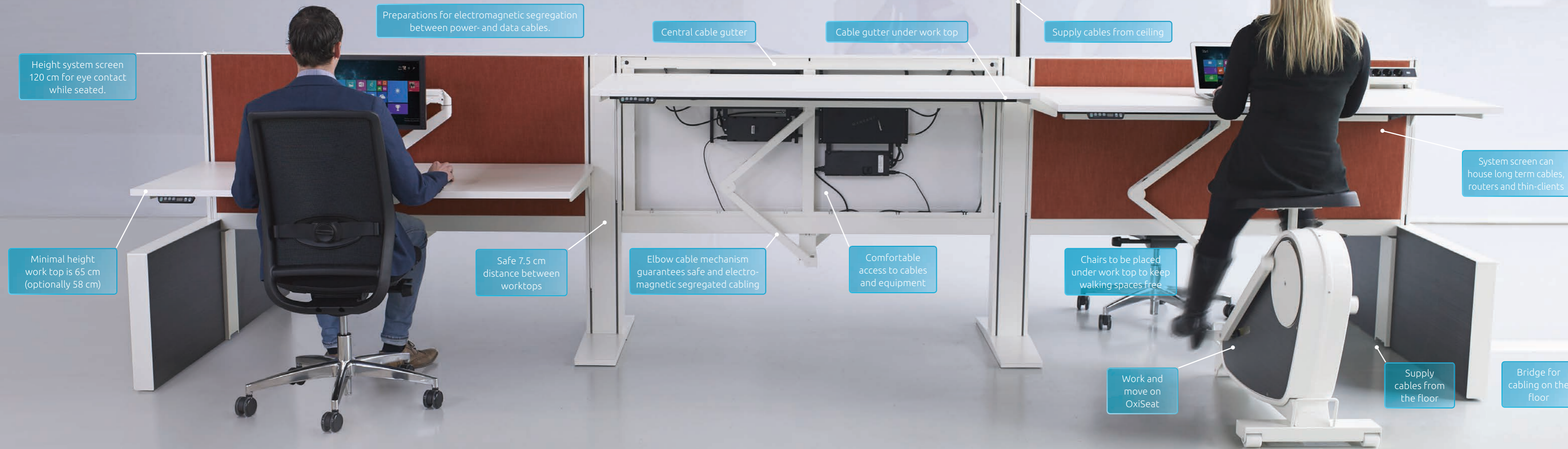

CABLE MANAGEMENT IN DETAIL

Cabling grouped workstations, with work tops that can be adjusted 70 cm in height, was central to the development of MAX. The cabling concept of MAX is divided into five segments of workplace cabling:

1. Connection of work spaces to building infrastructure

Cables coming from the floor can be tracked up along the legs or through MAX panels, screens or cabinets into the System screen. Inside the System screen excess of cables is stored.

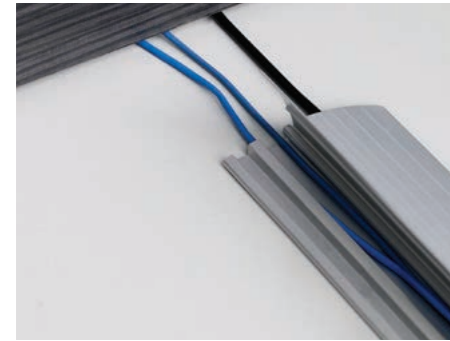

Supply cables on the floor



Supply cables on ceiling

Cables coming from the ceiling can be tracked through the central leg into the System screen or Central cable gutter.

2. Central cable gutter

At the top of the System screens runs the central cable gutter for interstation cable management. Mounts are installed for optional



Cabling through Central cable gutter (on top)

separation plates between data and power cables. Cable management is designed in such a way that wiring is not affected should you choose to upgrade the system.

3. Cable and equipment storage

Excess cables, network devices and thin clients are stored in the System screen that is easily and quickly accessible through removable panels.



Router placed in systemscreen

Ample vertical and horizontal gutters with cable guides provide for solid wiring. For heat creating equipment it may be necessary to apply the optional version of the ventilated System screen.



plug box in system screen

The System screen offers room for attachment of sockets and for storage of equipment (with a maximum thickness of 83mm). In the centre of the lower cable gutter is an exit-point for cables for on desk power which can be tracked up the cable elbow.

4. Cabling under the worktop

The MAX Elbow cable mechanism tracks segregated power and data cables from under the System screen to the the cable gutter under the worktop. In this gutter cables and sockets can also be stored.



Electro magnetic separation Elbow



Cables from Elbow to under-work-top cable gutter

5. Cabling on top the worktop

As standard, each workstation contains a large cable gutter, large enough to house GPO's and cables, allowing easy and neat access. From this gutter cables can moved above the work top.



Cable gutter under work top

Markant MediaSpace

Markant Media Space is a space for cable distribution and storage, with socket integration and system connectors for one or two monitor arms.

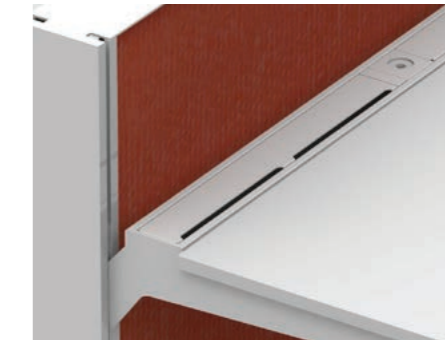

Markant MediaSpace

Markant MediaSpace is part of the worktop but integrated in the desktop frame. Cables from under do not go around the work top, but through Media space.

The Markant MediaSpace will replace the cable tray under the work top beginning of 2017.

BETTER DEALING WITH WEIGHT AND SPACE

The MAX Wing Ergocurve is a new concept for working and moving healthy, while saving on space.

Armrests

Arms weigh approximately a quarter of the total weight of the upper body which is carried by the spine and shoulders. Without adequate support, this weight can lead to neck strain and back problems.

The arms are completely supported from the elbow when using the MAX Wing Ergocurve. The pressure at the bottom of the spine is therefore reduced by about a quarter in both seated and standing positions. The comfortable armrests integrated into the Ergocurve reduce static strain in the neck muscles. For the spine of users this feels like standing partly in water, as though your arms are 'floating' on the worktop.

The advantage is that office workers enjoy the better support immediately and will stand more and longer with Wing Ergocurve. Users get less tired and experience less neck and back problems.

90% more workspace ¹

The MAX Wing version offers users up to 90% more primary countertop space compared to an 80cm x 180cm blade with an almost equal surface.

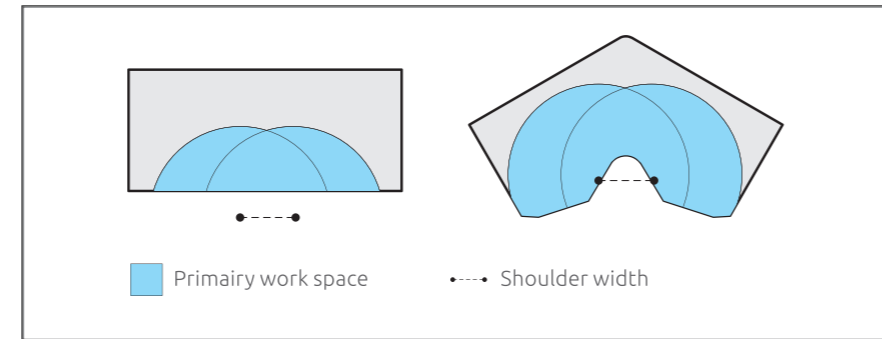

More walking space, while saving space.

The configurations shown, indicate that a Wing Ergocurve concept in comparison to the straight desk concept increases walking space between desks for employees encouraging movement without disturbing other workers.

Studies have shown that a short two minute walk every half hour can lower blood glucose levels by up to 30%. This small action is of most importance in the prevention of Diabetes Type II ².

1) This is from the average shoulder width (plan view) a circle of 60 cm around the shoulder joint projected on the worktop indicating the primary workspace that is also very accessible.

2) Citation: Pr. David Dunstan, Baker IDI Heart and Diabetes Institute, Melbourne, Australia.

HEIGHT ADJUSTMENT SYSTEMS

Technician Adjust (HI) is installed as standard in MAX systems without a drive unit, height range is 65-128 cm however is only recommended for sit to sit adjustment between users.

E-drive is the electric drive unit that can be retrofitted to the standard system. Speed of adjustment is 50 mm per second and the height range is 65 - 128 cm as standard. E-drive is complete with anti-collision software.

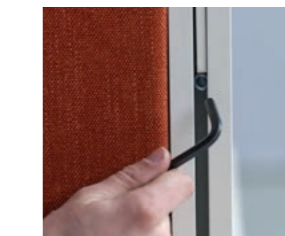

Height adjustable by Installers (HI)



E-Drive (electric)



F-Drive (Fast, non-electric)

F-drive is a non-electric drive unit that reduces the weight of the table to a few kilos. The worktop can be unlocked with the thumb to go downwards to a sitting position. Standing up requires no release. Adjustment is performed by the hand and legs of the user, using your body's own biometric memory. As long as your elbows are close to the body and at a right angle of 90 degrees, your table is set every time automatically at the correct Height both in sitting or standing position. The speed of adjustment is instantaneous- hence the name 'Follow Me'. Height adjustment is 65 - 128 cm as standard.

The figures below, show 2 x 24 workstations with equal surface.

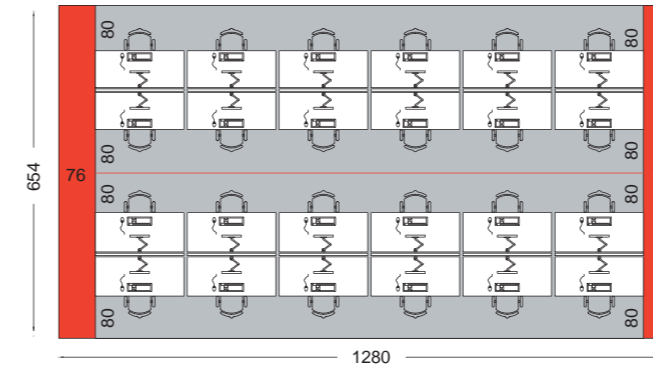

Rectangular tops (180x75) with no walking space. Users have little opportunity to move.

Above a configuration with rectangular tops. Under configurations with Wing Ergocurve blades. The private space for users is then set at 80 cm.

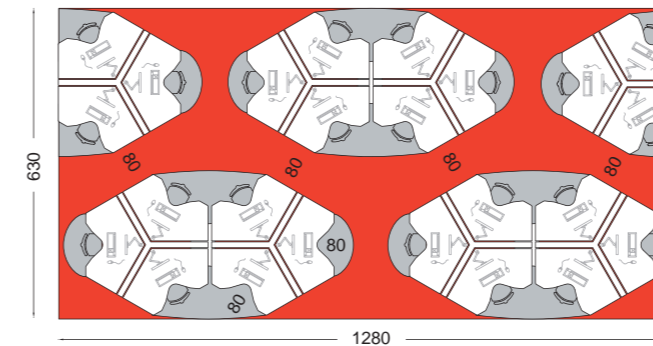

WING blade (120x120x75) with ample walking space. Users get optimum space for movement.

Personal space Walking space

MAX ACCESSORIES



Zoom 102

ZOOM 102 has two hinges, offering great flexibility to set up monitors at the right height and depth. The manual adjustment is ideal for users that have their own workstation as monitor adjustments are often made unnoticed. Users risk adapting to a wrong set up of the monitor with a potentially damaging posture as consequence.



Zoom Flex

The Zoom Flex allows one monitor to easily be adjusted by a supporting gas spring, offering ease and freedom with monitor adjustment. Ideal for shared workstations.



Zoom Flex Dual

The Zoom Flex allows two monitors to be easily adjusted. Supported by a more functional gas spring, it offers ease and freedom with monitor adjustment. Ideal for shared workstations.



Q4

Q4 is a solid modular and space-saving desktop solution for monitors. Individual, vertical height adjustment is made easy. The screen can tilt and rotate offering the benefit of landscape and portrait. The modular Q4 system enables tool-free height adjustment and efficient cable management.



Power sockets

Depending on the country, several options are available to distribute power and data. In MediaSpace sockets will be integrated.



CPU Holder

For desktop PCs with a separate screen, you can safely fit the CPU unit under the desk. Limiting dust accumulation and computer theft.

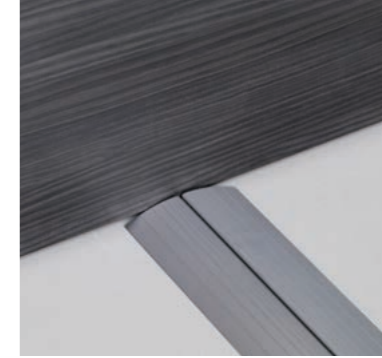

Cable Tunnel

A solution for power and data cables that are tracked from the floor or wall, preventing cable breakage and occupational hazards.



Cable Column

Power- and data cables can be passed from the ceiling to the System screen invisibly.

E-Drive or F-Drive?

MAX systems are installed with Technician Adjust (HI) as standard. Recommended for sit to sit adjustment. Later on it is easy to upgrade MAX sit workstations to sit-stand workstations.



E-Drive

Electric Drive Unit that can be retro fitted to MAX standard Technician adjust (HI). You can also purchase MAX with E-Drive already installed.

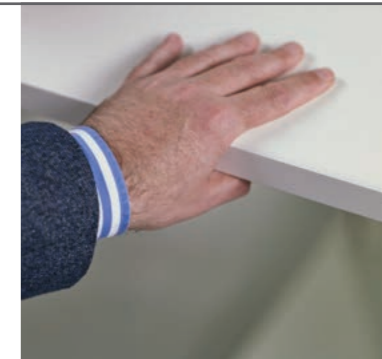

F-Drive

Non-Electric Drive unit that can be retro fitted to MAX standard Technician Adjust (HI). You can also purchase MAX with F-Drive already installed.

MAX HYBRID RANGE

The Markant MAX furniture line meets the need for sit-stand workplaces, acoustics, electrification and storage options. MAX is available in four different versions: a standalone T-leg frame, a Panel Range and a Screen Range.



MAX Hybrid Duo



MAX Hybrid 4



MAX Wing 3



MAX Hybrid Wing 6

MAX T-RANGE

With MAX T-RANGE, Markant offers an attractively priced combined desk that caters to all sit-stand requirements. Equipped with an acoustic System screen where electrification is fully integrated. Height: 120 cm, width: 160, 180 or 200 cm



MAX 2 T-Range



MAX 4 T-Range



MAX 6 T-Range



MAX 3 WING T-Range



MAX 6 WING T-Range

MAX PANEL RANGE

MAX Panel Range consists of clusters of workstations that are closed with panels ends for a more executive look. The design of these panels is modern and sleek with a steel shroud encasing the chosen wood decor. Height: 120 cm, width: 160, 180 or 200 cm



MAX 2 Panel Range



MAX 4 Panel Range



MAX 6 Panel Range



MAX 3 WING Panel Range



MAX 6 WING Panel Range

MAX SCREEN RANGE

MAX Screen Range is complete with upholstered end-panel screens. The acoustic properties and the extra privacy make the Screen Range ideal for call centers or concentration workplaces. Height: 120 cm, width: 160, 180 or 200 cm



MAX 2 Screen Range



MAX 4 Screen Range



MAX 6 Screen Range



MAX 3 WING Screen Range



MAX 6 WING Screen Range

TEN UNIQUE ADVANTAGES OF MAX

1   

Better implementation of Dynamic Working into the organization

Retrofit drive units allow gradual implementation of sit-stand desks. Cabling, laid out in the initial installation, remains untouched during the upgrade process. The (initial) shortage of sit-stand workstations, compels people to be more proactive to understand why they should be standing, making healthy working a privilege and not a chore.

2   

Invisible and simple installation of many cables

MAX integrates cabling from ceiling, floor and wall into the System screen, therefore cables can be tracked easily to other workstations. When required, data and power cables can be electromagnetically segregated. The System screen provides space for cables and equipment storage. From the System screen, running cables to the worktop is almost invisible.

3    

Wing Ergocurve is like standing partly in water

Users experience Wing Ergocurve as a similar experience for their spine as standing partly in water: 25% Less weight to be carried by the spine.

The integrated armrests in the wing blade with Ergocurve provide comfort and prevent bio-mechanical damage to neck, shoulders and lower back. Users experience 90% more useable work space on the worktop and up to four times more space for walking. Wing blade is ideal in combination with the Oxiseat.

4  

Future proof

Future technology of MAX can be applied later on in MAX frames (V2.x) of the present. Later upgrades or new modules are easily installed in the future due to the modularity of the screens, panels and worktops. If desired, fabric color, decor of worktops and functionality can be changed.

5 

No visible damage by different working heights

With the uniform height of 120 cm and dominance of the System screens, there is no visual damage to the interior to working groups whose workstations vary substantially in height. End and middle Screens are completely integrated in the design.

6   

Fastest height adjustment

E-drive, the electric drive unit, moves the worktop at a rate of 5 cm per second. F-Drive, the non-electric, biometric version, moves just as quickly in height as the user's touch and requirement.

7   

Most silent height adjustment

Both E-drive and F-drive are patented modules, enclosed in a box that is mounted inside the System screen. This cuts the motor noise substantially. Colleagues experience almost no noise when workstations are adjusted in height.

8      

Best Technology

Worktops hang from the System screen and do not stand on legs that stand in the way. MAX offers a unique choice between technician adjust, electric or non-electric height adjustment. The Installation time is short with almost no tools.

9   

Biggest adjustment range of table height

With any substantial order, the minimum height of MAX T-Range can be reduced to 58 cm, offering a 70 cm range of motion. This is for T Range only. With cabinets and panel ends, the adjustment range is 63 cm. Height range for MAX is 65 - 128 cm as standard.

10      

People-Planet-Profit

MAX furniture has a long economical life and meets the 'People-Planet-Profit principles' of circular economy.

-  Human Resources Management
-  Health
-  Facility Management
-  Financial Management
-  Productivity
-  Architecture

PEOPLE PLANET PROFIT

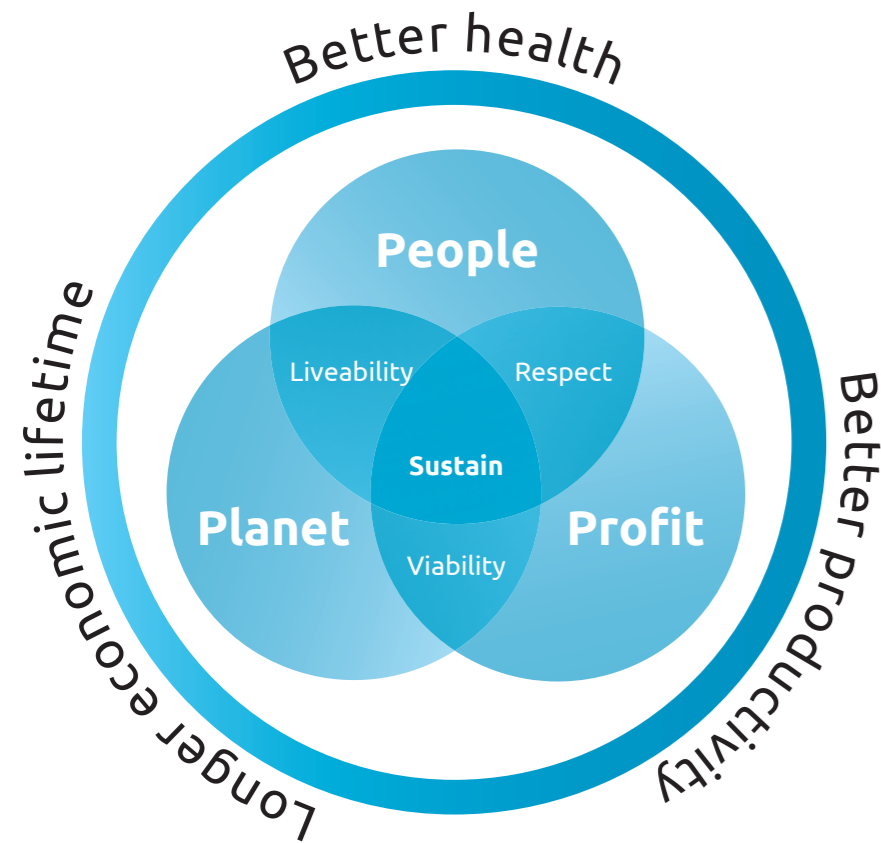

Respect defines the relationship between 'People' (pay and benefits) and 'Profit' (productivity and responsibility). MAX provides a substantial contribution to productivity for 'Profit' and health for 'People.'

Viability defines the feasibility of projects at the interface between 'Profit' and 'Planet'. If properly implemented, investments in MAX are paid back within one to two years and the environmental impact is minimal.

Liveability determines the feasibility of a project on the division between 'Planet' and 'People'. For example, the elimination of cars is good for 'Planet' but does not sufficiently find support from 'People'. End Users we have followed for several months are extremely pleased with the difference MAX has made in their organisation. The high degree of adaptability with finishes and functionality later on ensures a longer lifespan.

PEOPLE - Sustainable deployment of office workers

ICT developments over the last 20 years have enabled us to be more productive and efficient with our work. The disadvantage of this is that computers and monitors have lead us to be stationary for prolonged periods, dramatically decreasing movement throughout the day, with adverse consequences.

More than 415 million people worldwide are now living with diabetes, with the increased number of daily sitting hours, eating habits and lack of exercise being a major catalyst. If the sedentary lifestyle at the office does not change, healthcare costs will continue to rapidly increase and there will be

fewer and fewer prospects for office workers as they enter retirement. Changing lifestyle is much more important than the acquisition of sit-stand furniture for increased productivity and a healthier life.

When it comes to implementing change in the workplace, we must opt for interiors that facilitate that change. When the understanding is there, the action will follow. MAX has been developed on the principle of facilitating its implementation in organizations. It is an investment in health.

Markant encourages office workers to make adjustments throughout their daily life at work and at home to change sedentary behaviour. Alternate between sitting and standing, or even better, make a short two minute walk every half an hour. Count your steps, try to hit 10,000 steps five days a week and exercise regularly.

This is not only a long term investment, it also sees short term results. Improved mood and confidence, decreased stress, less truancy from sickness, and much more energy during the day and evenings.

PLANET - Prolonging economic life

The enormous possibilities of MAX provide for ecological profit. All components are reusable, upgradeable, interchangeable and recyclable. Future proof design allows the panel concepts for fabric and decor finishes to be changed, years after the workstation is installed. Increasing the economic lifespan of MAX.

Drive elements are modular so that the piece of furniture in the course of time can be easily upgraded to new possibilities with retention of the originally supplied framework.

MAX furniture contains more than 97% recyclable materials. Ecopanel can be used as covers of System screens and consist of 100% PET (100 % recycled) material. Desktops carry the FSC® and PEFC™ label. MAX is certified as Global GreenTag Level B.

PROFIT - More profits through increased productivity

Companies can see a return on their investment on MAX by way of increased productivity, creativity and lowered absenteeism. Happier, healthy more productive staff will see an increase in bottom-line profit.

MARKANT

'It's about the way you work'

The Netherlands

Elzenkade 1

3992 AD Houten

T +31 (0) 30 693 69 69

E sales@markantoffice.com

Asia Pacific

Malaysia

Lot 523, Batu 13 1/2 Jalan Klang Banting

42600 Jenjarom Selangor

T +60 3 3191 7246

Australia

Level 1/175 Collins Street

VIC 3000 Melbourne

T +61 38102 9031

markantoffice.com