

howgroup.

SPACE40



About us

We create efficient and inspiring spaces by working collaboratively with architects, designers and industry professionals.

Howgroup is more than a furniture supplier; we listen to our clients' vision and transform their ideas into spaces that are beautiful, functional and comfortable by offering tailored, innovative solutions across a multitude of commercial sectors. From floor to ceiling, and wall to wall, our product range offers endless options for transforming any space and we are here to support you as the needs of the space evolve.

Howgroup specialises in providing solutions across Workplace, Education, Government, Hospitality and Aged Care sectors and delivers projects Australia-wide.

Culture

Howgroup was established by Paul Howard (Director) and Faith Sun (General Manager). With over 50 years' industry experience between them, beginning with Ian Howard establishing in 1946 Aristoc Industries, Featherston Interiors & CoDesign, Paul and Faith created Howgroup after recognising the market was flooded with manufactures and suppliers telling designers and architects what they needed, rather than adapting to the ever-evolving needs and requests of their clients' brief. By combining a genuine passion for industrial design and a wealth of knowledge in furniture manufacturing and project delivery space, we have become a modern version of a solid model of principles long established, continually adapting to the world today.

Knowledge

Our long-standing relationships with industry-leading brand partners together with our own Australian manufacturing production, enable us to support the evolution of industrial design, working closely with Australian & international designers.

With extensive industry connections, we have the capacity to provide complete space solutions; from front of house to the back office & collaboration spaces. We provide clear and transparent pricing and are more than happy to assist with images, presentations and other marketing materials to help our clients get their projects over the line.



WORKTOPS

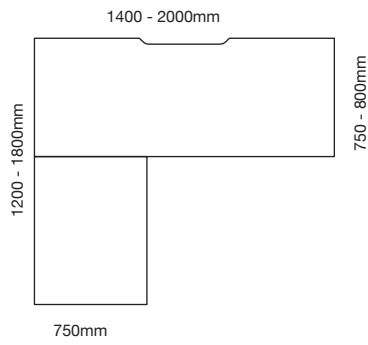
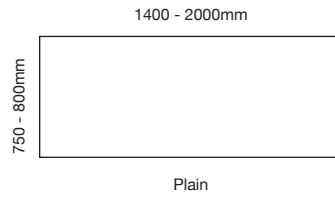
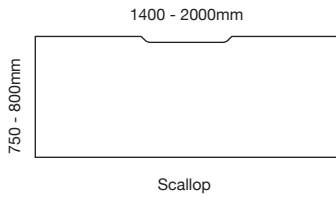

SCREENS

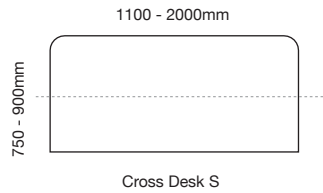
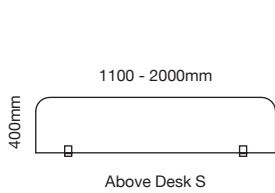

ESSENTIAL SINGLE DESK (NO SCREEN)

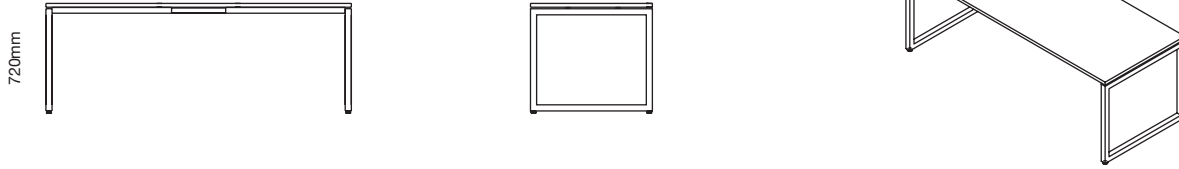

CLASSIC SINGLE DESK

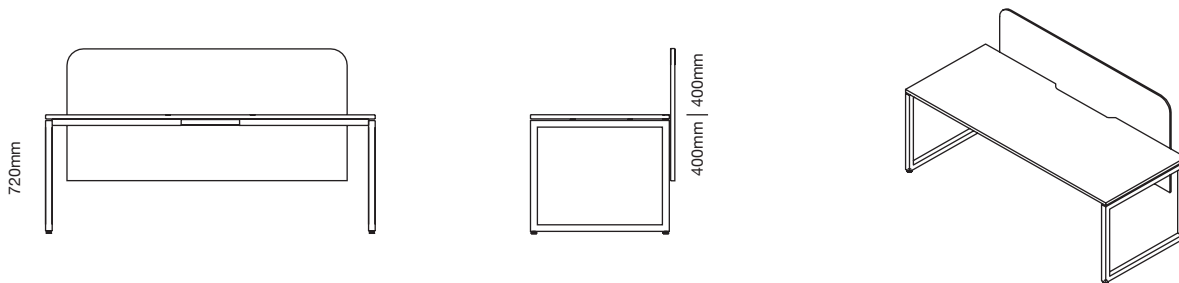

SIDEBYSIDE SINGLE DESK

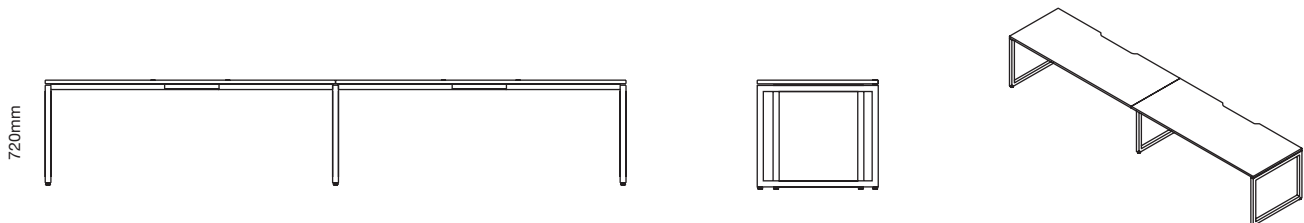

ESSENTIAL B2B WORKSTATION (NO SCREEN)

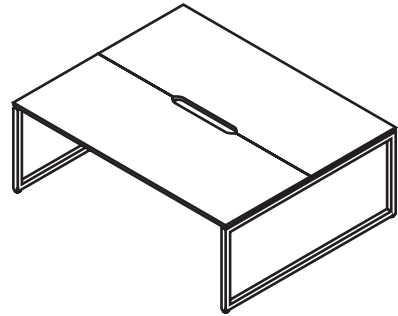
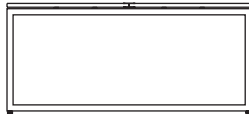

CLASSIC B2B WORKSTATION (ABOVE DESK SCREEN)

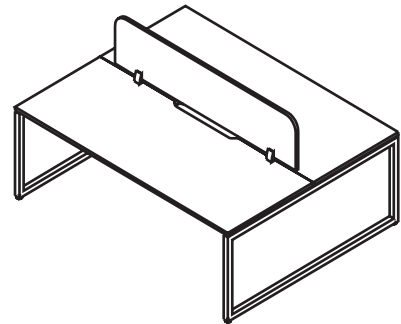
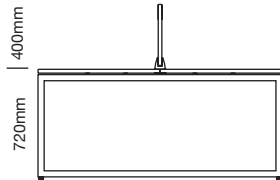
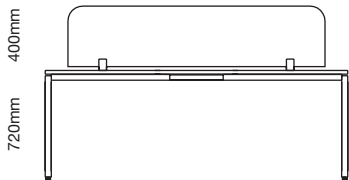

CLASSIC B2B WORKSTATION (CROSS DESK SCREEN)

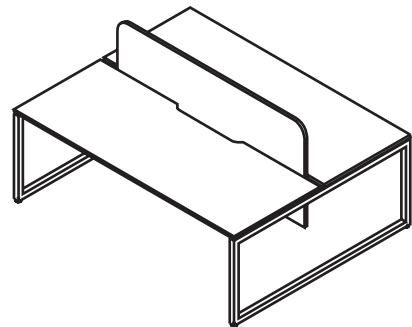
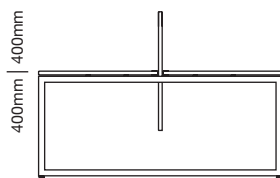
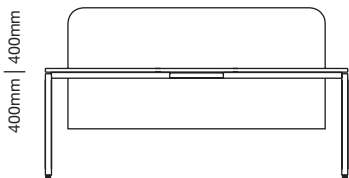

B2B 4 WORKSTATION

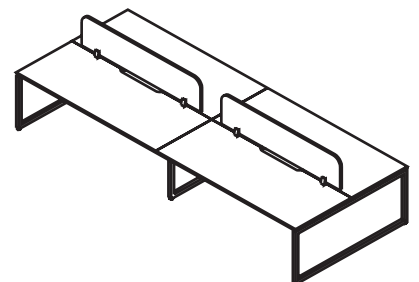
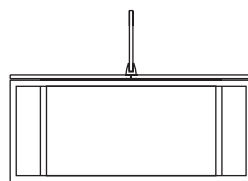
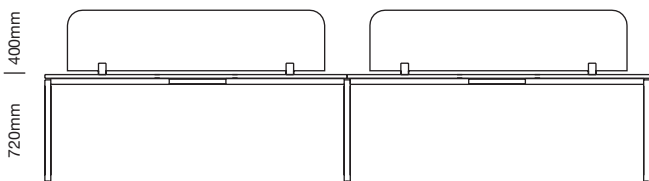

ESSENTIAL L WORKSTATION (NO SCREEN)

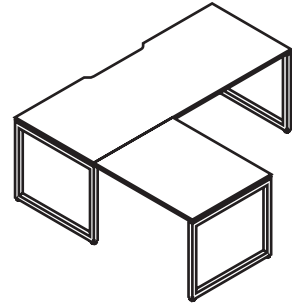
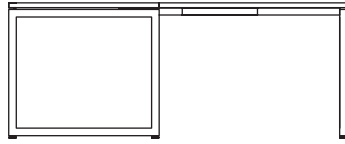
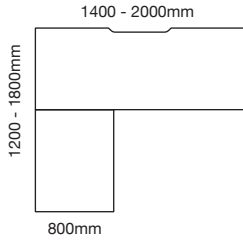





ECHOPANEL® 12MM



ECHOPANEL® 101 12MM



ECHOPANEL® 108 12MM



ECHOPANEL® 124 12MM



ECHOPANEL® 193 12MM

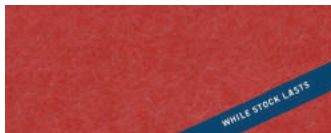

ECHOPANEL® 258 12MM
While Stocks Last



ECHOPANEL® 269 12MM



ECHOPANEL® 274 12MM



ECHOPANEL® 276 12MM



ECHOPANEL® 295 12MM



ECHOPANEL® 325 12MM

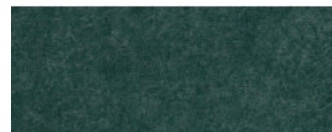

ECHOPANEL® 330 12MM



ECHOPANEL® 338 12MM



ECHOPANEL® 349 12MM



ECHOPANEL® 365 12MM

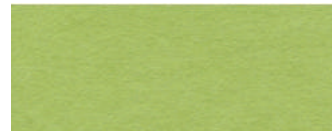

ECHOPANEL® 381 12MM



ECHOPANEL® 384 12MM



ECHOPANEL® 402 12MM

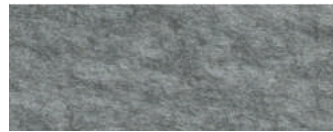

ECHOPANEL® 442 12MM



ECHOPANEL® 444 12MM



ECHOPANEL® 454 12MM



ECHOPANEL® 468 12MM



ECHOPANEL® 487 12MM

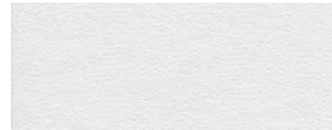

ECHOPANEL® 500 12MM

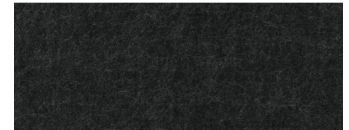

ECHOPANEL® 542 12MM

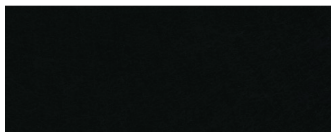

ECHOPANEL® 550 12MM



ECHOPANEL® 551 12MM



ECHOPANEL® 576 12MM

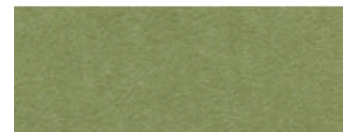

ECHOPANEL® 579 12MM



ECHOPANEL® 580 12MM



ECHOPANEL® 633 12MM

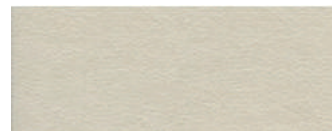

ECHOPANEL® 908 12MM



ECHOPANEL® 660 12MM



DESIGNER:
WOVEN IMAGE

CATEGORY:
ACOUSTIC SOLUTIONS
ECHOPANEL 12MM
WALL PANEL

COMPOSITION:
100% PET (60% RECYCLED)

WEIGHT:
APPROX. 8KG PER PANEL





ECHOPANEL® 24MM



ECHOPANEL® 101 24MM



ECHOPANEL® 325 24MM



ECHOPANEL® 330 24MM



ECHOPANEL® 365 24MM



ECHOPANEL® 402 24MM



ECHOPANEL® 442 24MM

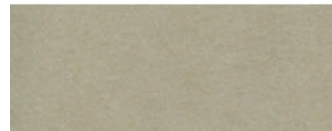

ECHOPANEL® 468 24MM

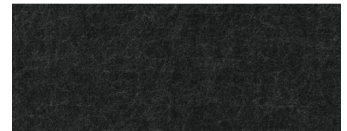

ECHOPANEL® 542 24MM



ECHOPANEL® 550 24MM



ECHOPANEL® 908 24MM

DESIGNER:
WOVEN IMAGE

CATEGORY:
SPACE-DIVIDERS
ECHOPANEL 24MM
ACOUSTIC SOLUTIONS

COMPOSITION:
100% PET (60% RECYCLED)

WEIGHT:
3000G/M2

DIMENSIONS:
2400 X 1820MM

THICKNESS:
24MM

SOUND ABSORPTION:
AS ISO 354 - 2006
NRC VALUE: 0.65 (NO AIR GAP)
NRC VALUE: 0.75 (20MM AIR GAP)
NRC VALUE: 0.85 (50MM AIR GAP)

LIGHTFASTNESS:
ISO 105-B02 - 1994 RATING: 6-7
AS 2001.4.21-1970 RATING: 6-7

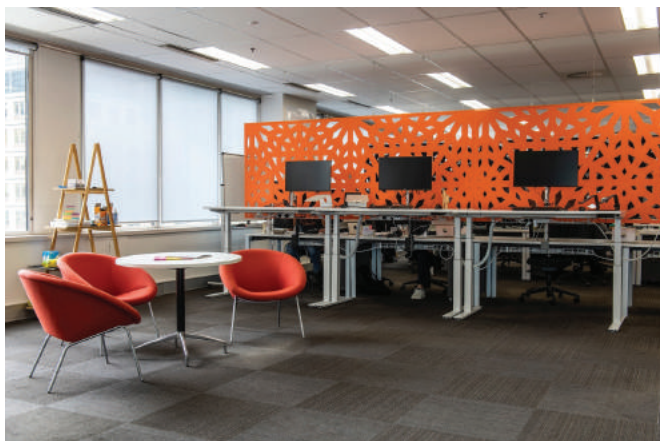





LIBERTY TASK

designed by Niels Diffrient

The Liberty Task chair is an intelligent mesh task chair engineered to provide automatic lumbar support for every user, as well offering simplicity and complete ease of use. Liberty was designed to offer a unique, minimal aesthetic and to provide custom comfort for every person who sits in it. Like Humanscale's Diffrient Smart and Diffrient World chairs, Liberty uses Humanscale's revolutionary Form-Sensing Mesh Technology and mechanism-free recline for perfect support and unprecedented comfort.



DIFFRIENT SMART

designed by Niels Diffrient

The Diffrient Smart chair is an intelligent mesh task chair with a striking linear aesthetic that complements any environment. Engineered to provide automatic lumbar support for every user, as well as simplicity and ease of use, Diffrient Smart offers comfort, style and flexibility. Diffrient Smart was created by designer Niels Diffrient and, like Humanscale's Liberty and Diffrient World chairs, uses Humanscale's revolutionary Form-Sensing Mesh Technology and mechanism-free recline for perfect support for every user.



GESTURE Mesh Chair

High quality mesh task or executive arm chair. Synchronised back rest and seat allow for adjusting position to suit task, while seat slide and lumbar support the back and legs.

The seat is upholstered in light grey fabric as standard, Bifma and Greenguard approved and backed by a 10 year warranty.



ERGO Task

The Ergo task comes with a full set of adjustments to assist in supporting you in a full range of tasks. Suited to heavy duty use with seat slide for extra seat depth and ratchet back for extra back height and a fully ergonomic mechanism for seat and back adjustment.

AFRDI and BIFMA tested with Green Guard Gold certification backed by a 10 year warranty.



STAY

ERGONOMIC

The innovative design of the back offers a great deal of freedom of movement. The seat and the armrests allow total adjustment from the seated position, ensuring that the user uses minimum effort to maintain or change their position.



TRIM

ADJUSTABLE BACKREST

Personalisation

This chair offers extensive customisation options and features with an adjustable backrest, which enhances comfort. High technical specifications combined with very competitive prices.





Revolve Monitor Arm

Liberate your work top space and improve posture with a Revolve pole mounted dual monitor arm.

With 360 degree horizontal adjustment and cable management within the pole, and backed by a 3 year warranty.



FLO Monitor Arm

Liberate your work top space and improve posture with a Revolve pole mounted dual monitor arm.

With 360 degree horizontal adjustment and cable management within the pole, and backed by a 3 year warranty.



M/CONNECT™ 2 Docking Station

Introducing M/Connect 2 — a new USB docking station that provides power delivery to USB-C and Thunderbolt notebooks while being backwards compatible to USB 3.0 notebooks. This offers a universal solution during the transition from USB 3.0. M/Connect 2 can be integrated into any Humanscale Monitor Arm or be independently mounted to the desk without an arm.

M/Connect 2's innovative split dock technology allows all cables to be connected under the desk and off the work surface, which limits accessibility to connections the user doesn't require. An easily accessible hub on the desk provides the user with immediate access to data, charging and audio ports.

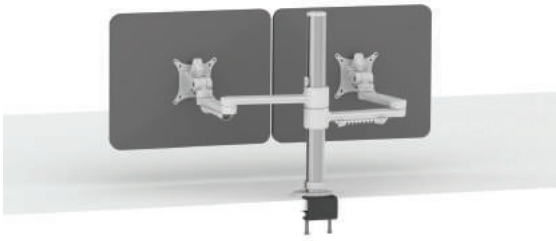

C.ME

Designed considering user friendly operation, simple clean lines, an environmental focus, and good looking aesthetic, the C.ME Monitor Arm is very easy to assemble and install. C Me is available as a single arm, dual arm, triple arm, or quad arm support in three colour options – white, polished and black.

An easy and safe pushbutton mechanism allows the monitor to be adjusted from a seated position. A quick release mechanism with 90-degree portrait to landscape screen rotation and secure fastening option and discreet, effective cable management are stand-out features of this elegant, simple design. Bolt through or desk clamp mounting are both included as standard.



M8.1

In today's fast-paced, agile work environment, there's no time for discomfort. M8.1, part of Humanscale's revolutionary new monitor arm line, instantly improves the comfort, health and productivity of any workspace. Fully compatible with traditional desks and sit/stand workstations alike, M8.1 meets a variety of configuration needs for single monitors from 6 to 28 pounds or – with an optional crossbar support – dual monitors up to 12 pounds each.

Featuring innovations like Humanscale's patented Weight-Compensating Spring Technology and Smart Stop functionality, M8.1 enables the personalization and flexibility needed for today's evolving workplaces.



Below Desk Power



50mm Tile C/W 45 Degree Deep Data Tile To Suit Clipsal/Krone Jacks

Product Description
50mm Tile c/w 45 degree angled data. Clipsal/Krone.
Available in White (WT) or Black (BK). **Denotes colour



Single Tier C/W 1 X Tray And 2 X Mounting Brackets – 1250mm



Rotated Quad Auto Switched Power Module

Product Description
Available in White (WT), Black (BK), Silver (SL), Blue (BL) or Red (RD). **Denotes colour



Above Desk Power Rails

2 X Rotated GPO And Inline USB-A/A Fast Charge

Product Description
Includes 650mm lead, L3T splitter & desk clamps



Zeus II c/w 2 x rotated auto switched GPO and 2 x USB chargers

Product Description
500mm lead, L3T splitter & desk clamps



Soft Wiring In-Desk Modules

Surface Mount Box C/W 2 X Auto Switched GPO And 2 X USB Charging Ports.



Konexus 10A Module, 2 X USB Chargers, Provision For 1 X Keystone Jack, 500mm Tag Lead & L3D Splitter



Pop-Up 1 X GPO With 2 X USB Chargers, 500mm Tag Lead



Echo Wireless fast-charge module (15W), 1500mm lead with 3-pin plug.

Product Description
Echo Wireless fast-charge module (15W), 1500mm lead with 3-pin plug.



Echo USB C/A PD fast-charge module (30W shared), 1500mm lead with 3-pin plug.

Product Description
Echo USB C/A PD fast-charge module (30W shared), 1500mm lead with 3-pin plug.



Echo GPO, 1500mm lead with 3-pin plug.

Product Description
Echo GPO, 1500mm lead with 3-pin plug.





howgroup.

Studios:
Melburnian
Grnd Fl, 2/250 St Kilda Road
Southbank VIC 3006

Perth
Grnd Fl, 160 Beaufort Street
Perth WA 6000

Factory & Warehouse
9-19 Leakes Rd,
Laverton Nth VIC 3026

PO Box:
33332, St Kilda Road,
Melbourne VIC 3004

Tel: +61 3 8360 9631
sales@howgroup.com.au
www.howgroup.com.au